

HON. NOW™

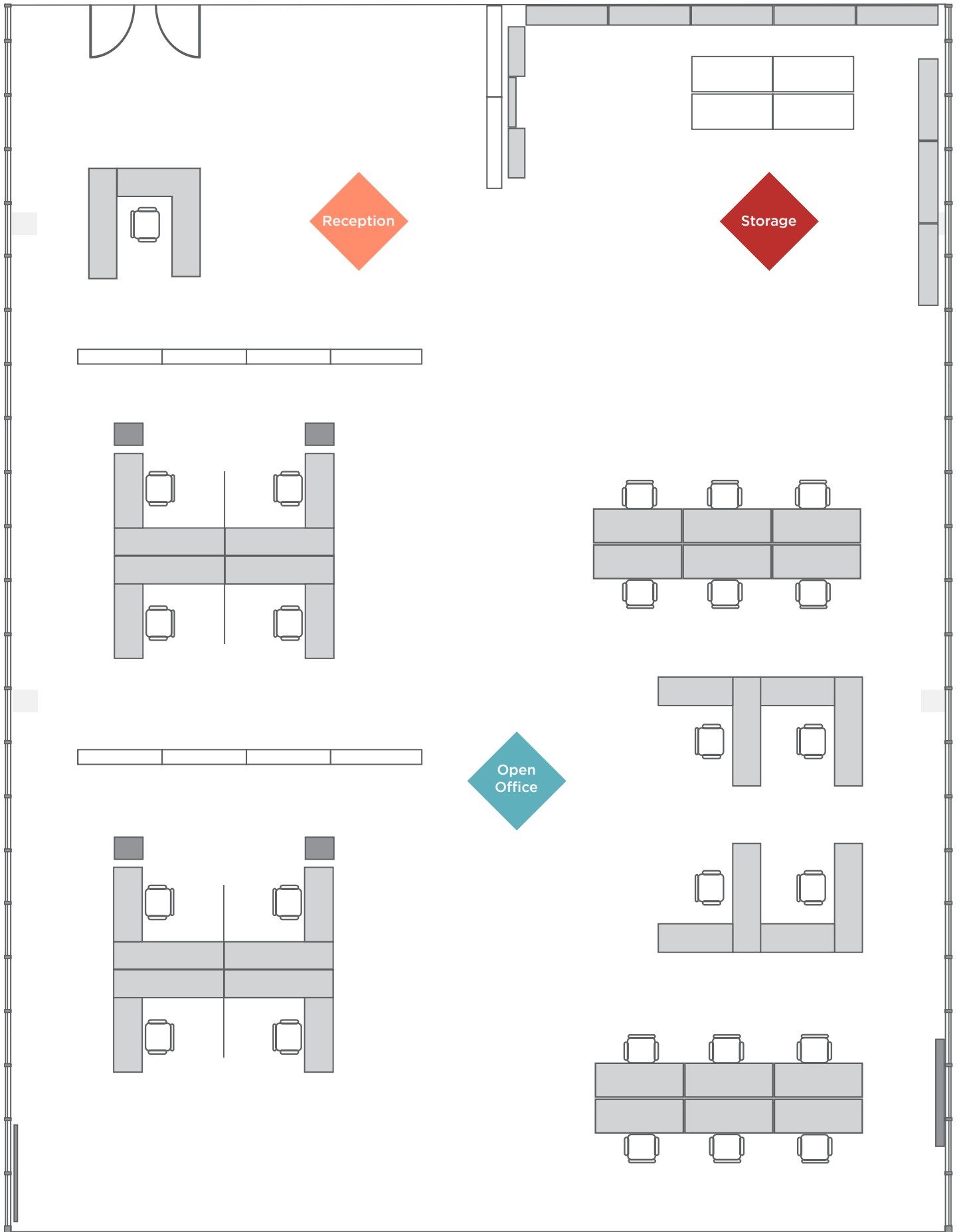

MAKING SELECTION STRESS FREE

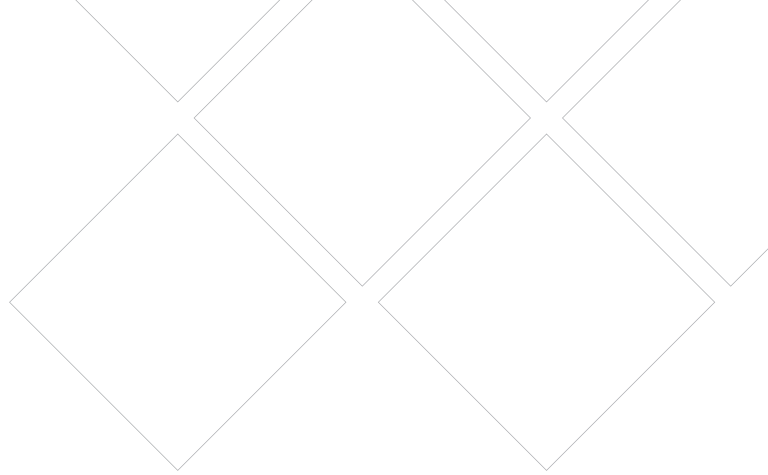







The Program That Delivers

Today's fast-paced companies have to be ready for anything. That's why we created HON NOW, a one-of-a-kind program that combines style, selection and quality construction to provide unparalleled value. We know you're busy. That's why we made the program so easy to use. You get the furniture you need faster than ever before, at a better value than you'll find anywhere else. Add the confidence you'll receive from the industry-leading warranties, and it's easy to see why HON NOW will quickly become one of your most valuable business assets.

Table of Contents

 OPEN OFFICE		 SEATING	10
- Individual	4-5		
- Teaming	6-7	 STORAGE	11
 RECEPTION	8-9	 TABLES	12



A LITTLE ALONE TIME

These workstations are customized for focused, individual work, providing privacy, storage, technology and room to spread out and get things done.

INDIVIDUAL WORKSTATION IDEA STARTERS

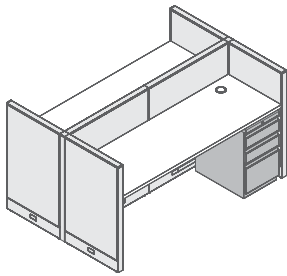

48"W x 60"D
Shown as a 2-pack

Focus Collaboration

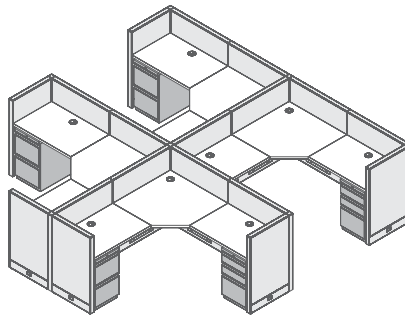

144"W x 144"D
Shown as a 4-pack

Focus Collaboration

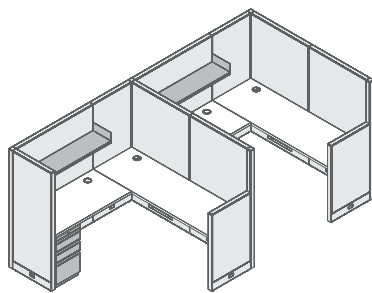

144"W x 72"D
Shown as a 2-pack

Focus Collaboration

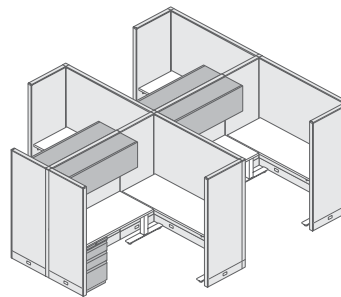

144"W x 120"D
Shown as a 4-pack with height-adjustable worksurfaces

Focus Collaboration

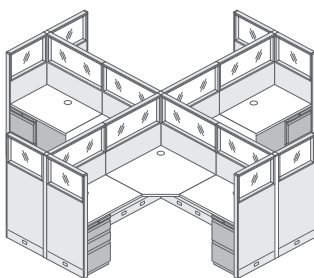

144"W x 144"W
Shown as a 4-pack with glass stackers

Focus Collaboration



GLASS PANELS

Add 15" glass stackers and gain access to natural light while increasing acoustical privacy.



HEIGHT- ADJUSTABILITY

Add height-adjustability to any workstation for a healthier work style.

FINISHING TOUCH

HON NOW material selections have been carefully selected by designers to coordinate, however you mix and match.

LAMINATE FINISHES

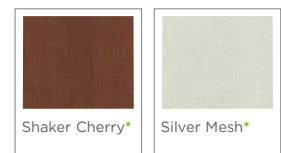

PANEL FABRICS

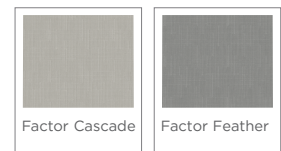

PAINT



LEG FINISH*

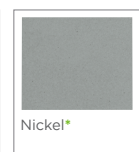

* Indicates finishes available for height-adjustable

◆ Looking for something else? Let us customize your workstation using the HON NOW assortment.



GO TEAM GO

Project teams need to balance impromptu collaboration with extended periods of individual focus to maximize productivity. Connected surfaces with storage is the perfect combination to win every workday.

TEAMING WORKSTATION IDEA STARTERS

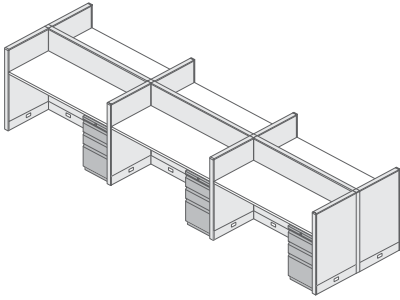

180"W x 48"D
Shown as a 6-pack

Focus Collaboration

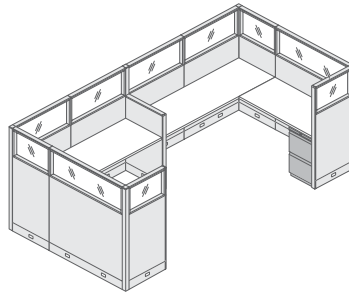

144"W x 72"D
Shown as a 2-pack with glass stackers

Focus Collaboration

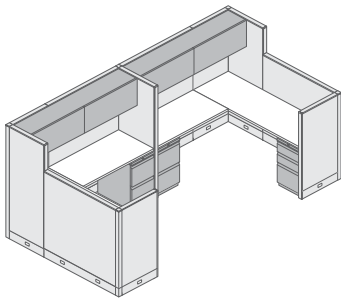

144"W x 72"D
Shown as a 2-pack

Focus Collaboration



HEIGHT- ADJUSTABILITY

Add height-adjustability to any workstation for a healthier work style.

FINISHING TOUCH

HON NOW material selections have been carefully selected by designers to coordinate, however you mix and match.

LAMINATE FINISHES



Shaker Cherry*



Silver Mesh*

PANEL FABRICS



Factor Cascade

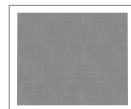

Factor Feather

STORAGE



Loft

LEG FINISH*

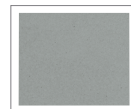

Nickel*

* Indicates finishes available for height-adjustable

◆ Looking for something else? Let us customize your workstation using the HON NOW assortment.



SETTING THE TONE

Your welcoming area says a lot about your business, and even more about what you think of your guests. A cohesive workstation says, "we value your opinion." A comfortable seat says, "we're glad you're here." HON NOW offers exactly what you need to say exactly what you want to say.

RECEPTION IDEA STARTERS

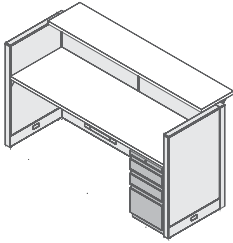

36"W x 24"D
42"H Panels

Worksurface Storage

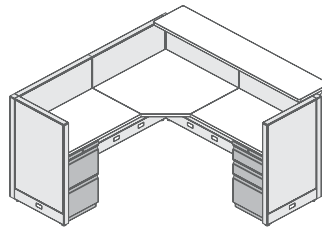

72"W x 96"D
42"H Panels and 65"H Panels

Worksurface Storage

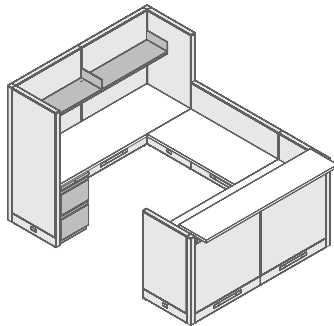

72"W x 72"D
42"H Panels

Worksurface Storage

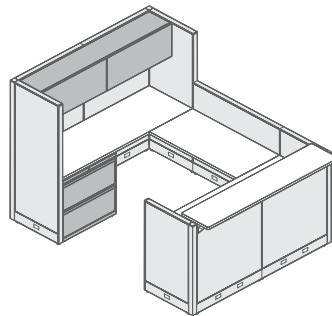

72"W x 72"D
42"H Panels

Worksurface Storage



TRANSACTION COUNTER

Conduct business with ease by adding a transactional counter to any reception workstation.



HEIGHT-ADJUSTABILITY

Add height-adjustability to any workstation for a healthier work style.

FINISHING TOUCH

HON NOW material selections have been carefully selected by designers to coordinate, however you mix and match.

LAMINATE FINISHES



Shaker Cherry*



Silver Mesh*

PANEL FABRICS

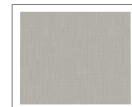

Factor Cascade

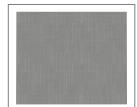

Factor Feather

PAINT



Loft

LEG FINISH*



Nickel*

* Indicates finishes available for height-adjustable

◆ Looking for something else? Let us customize your workstation using the HON NOW assortment.



Solve Task Chair
Ink Upholstery,
Adjustable Lumbar,
Mesh Back



**Ignition 2.0
Mid-Back Task Chair**
Black Mesh and
Black Upholstery,
Adjustable Lumbar



Convergence Task Chair
Black Upholstery,
Adjustable Lumbar,
Mesh Back

THE SUPPORTING CAST

From private and open offices to dedicated and informal meeting spaces, businesses need solutions that support a variety of workers, postures and personal preferences. The right seating mix from HON NOW helps you support all the ways work gets done.



HON NOW Lateral and Pedestal Files

STOW AND GO

Need a storage solution for a workstation? No problem. Looking for creative ways to archive your files? We've got that, too. From active to archival to communal storage, our collections combine to create versatile layouts that maximize space, define boundaries and bring people closer to the things they need to stay productive.



LOCKABLE

Secure valuables when needed.

STORAGE FINISHES

All storage solutions are available in a neutral loft finish.

PAINT





HON NOW height-adjustable base, 3 stage with optional memory control, worksurface Silver Mesh Laminate
Also available in Shaker Cherry



Desktop Riser with keyboard tray
Also available in White



Directional Sit-to-Stand

HEIGHT ADJUSTABLE TOP

LAMINATE FINISHES

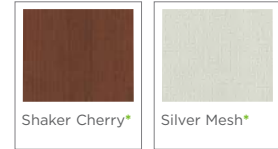

DESKTOP RISER FINISHES

PAINT

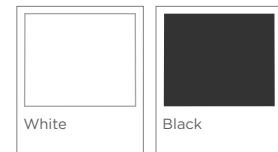

HON®

The HON Company
 200 Oak Street, Muscatine, IA 52761
 800.833.3964 | hon.com

© 2018 The HON Company. Form No. H5231 (1/18)
 To view the registered and unregistered trademarks owned and used by The HON Company, visit hon.com/protected-marks. Models, upholstery and finishes are subject to change without notice.